

The input COM terminal must be connected to 0V

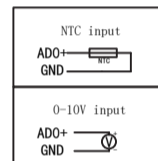

The input COM terminal must be connected to 0V

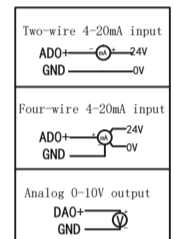
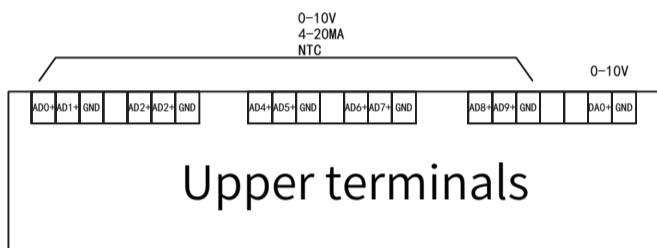
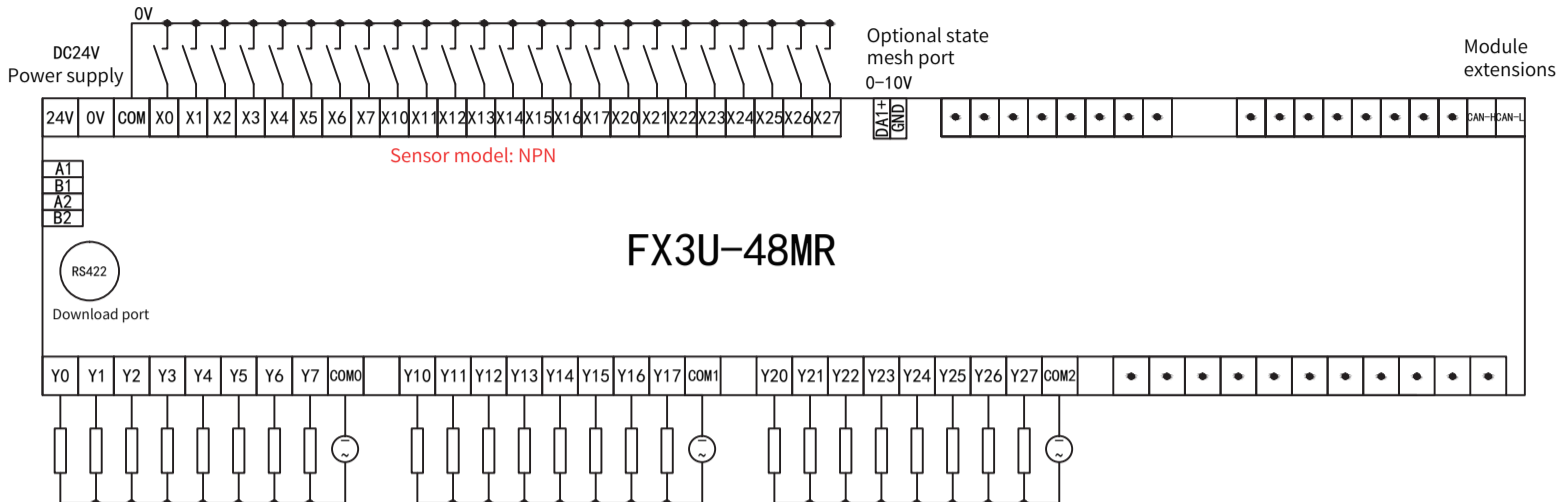
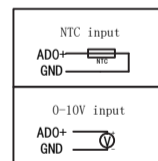
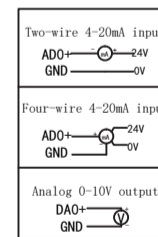
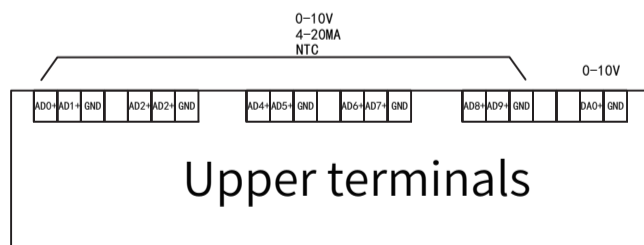
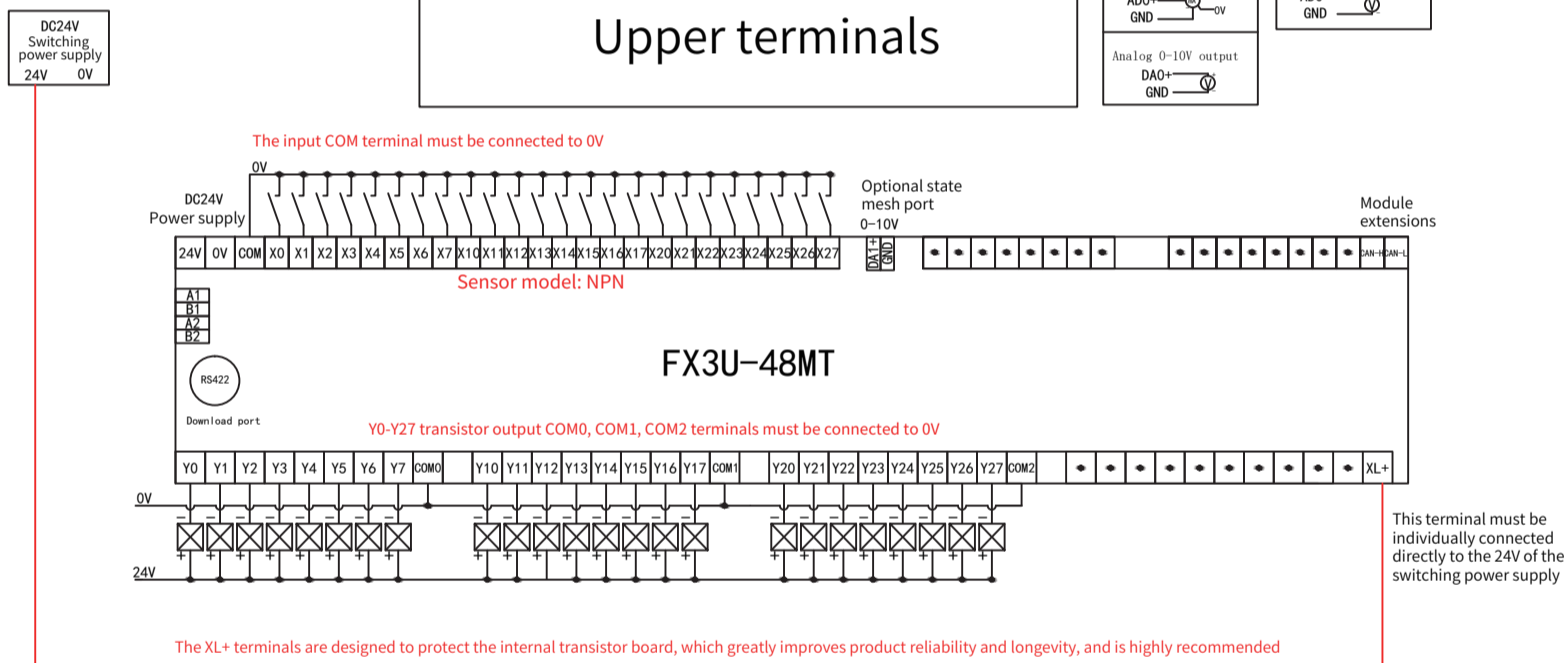

The input COM terminal must be connected to 0V

